

JVC

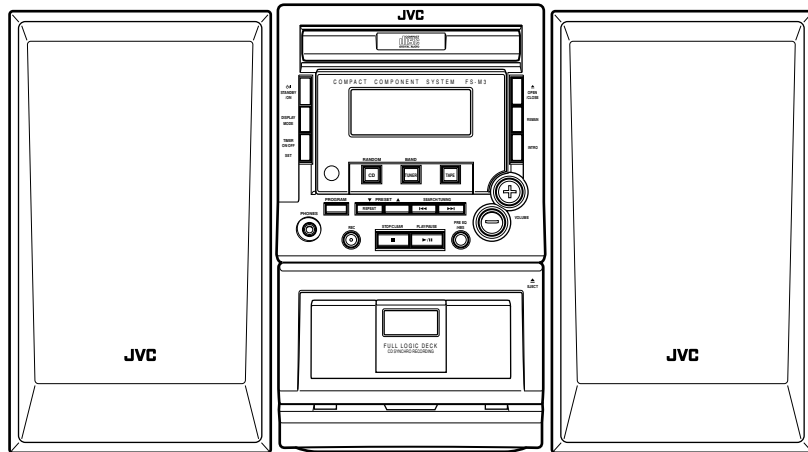

COMPACT COMPONENT SYSTEM

FS-M3

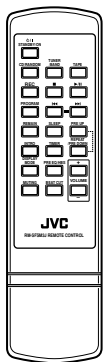

COMPACT
disc
DIGITAL AUDIO

INSTRUCTIONS

For Customer Use:

Enter below the Model No. and Serial No. which are located either on the rear, bottom or side of the cabinet. Retain this information for future reference.

Model No. _____

Serial No. _____

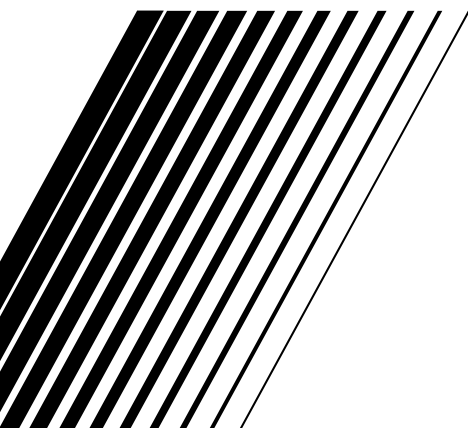

Warnings, Cautions and Others Mises en garde, précautions et indications diverses

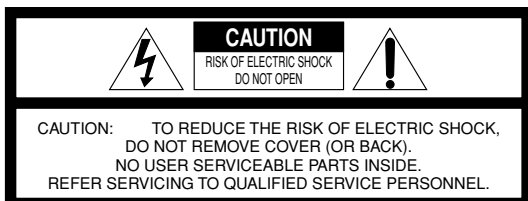

The lightning flash with arrowhead symbol, within an equilateral triangle is intended to alert the user to the presence of uninsulated "dangerous voltage" within the product's enclosure that may be of sufficient magnitude to constitute a risk of electric shock to persons.



The exclamation point within an equilateral triangle is intended to alert the user to the presence of important operating and maintenance (servicing) instructions in the literature accompanying the appliance.

WARNING: TO REDUCE THE RISK OF FIRE OR ELECTRIC SHOCK, DO NOT EXPOSE THIS APPLIANCE TO RAIN OR MOISTURE.

CAUTION

To reduce the risk of electrical shocks, fire, etc.:

1. Do not remove screws, covers or cabinet.
2. Do not expose this appliance to rain or moisture.

ATTENTION

Afin d'éviter tout risque d'électrocution, d'incendie, etc.:

1. Ne pas enlever les vis ni les panneaux et ne pas ouvrir le coffret de l'appareil.
2. Ne pas exposer l'appareil à la pluie ni à l'humidité.

For U.S.A.

This equipment has been tested and found to comply with the limits for a Class B digital device, pursuant to part 15 of the FCC Rules.

These limits are designed to provide reasonable protection against harmful interference in a residential installation.

This equipment generates, uses and can radiate radio frequency energy and, if not installed and used in accordance with the instructions, may cause harmful interference to radio communications. However, there is no guarantee that interference will not occur in a particular installation. If this equipment does cause harmful interference to radio or television reception, which can be determined by turning the equipment off and on, the user is encouraged to try to correct the interference by one or more of the following measures:

- Reorient or relocate the receiving antenna.
- Increase the separation between the equipment and receiver.
- Connect the equipment into an outlet on a circuit different from that to which the receiver is connected.
- Consult the dealer or an experienced radio/TV technician for help.

Caution — STANDBY/ON button!

Disconnect the mains plug to shut the power off completely. The STANDBY/ON button in any position does not disconnect the mains line. The power can be remote controlled.

Attention — Commutateur STANDBY/ON !

Déconnecter la fiche de secteur pour couper complètement le courant. Le commutateur STANDBY/ON ne coupe jamais complètement la ligne de secteur, quelle que soit sa position. Le courant peut être télécommandé.

For Canada/pour le Canada

CAUTION: TO PREVENT ELECTRIC SHOCK, MATCH WIDE BLADE OF PLUG TO WIDE SLOT, FULLY INSERT.

ATTENTION: POUR ÉVITER LES CHOCS ÉLECTRIQUES, INTRODUIRE LA LAME LA PLUS LARGE DE LA FICHE DANS LA BORNE CORRESPONDANTE DE LA PRISE ET POUSSER JUSQU'AU FOND.

Note to CATV system installer:

This reminder is provided to call the CATV system installer's attention to Section 820-40 of the NEC which provides guidelines for proper grounding and, in particular, specifies that the cable ground shall be connected to the grounding system of the building, as close to the point of cable entry as practical.

For Canada/pour le Canada

THIS DIGITAL APPARATUS DOES NOT EXCEED THE CLASS B LIMITS FOR RADIO NOISE EMISSIONS FROM DIGITAL APPARATUS AS SET OUT IN THE INTERFERENCE-CAUSING EQUIPMENT STANDARD ENTITLED "DIGITAL APPARATUS," ICES-003 OF THE DEPARTMENT OF COMMUNICATIONS.

CET APPAREIL NUMÉRIQUE RESPECTE LES LIMITES DE BRUITS RADIOÉLECTRIQUES APPLICABLES AUX APPAREILS NUMÉRIQUES DE CLASSE B PRÉSCRITES DANS LA NORME SUR LE MATÉRIEL BROUILLEUR: "APPAREILS NUMÉRIQUES", NMB-003 ÉDICTÉE PAR LE MINISTRE DES COMMUNICATIONS.

1. CLASS 1 LASER PRODUCT
2. **DANGER:** Invisible laser radiation when open and interlock failed or defeated. Avoid direct exposure to beam.
3. **CAUTION:** Do not open the top cover. There are no user serviceable parts inside the Unit; leave all servicing to qualified service personnel.

1. PRODUIT LASER CLASSE 1
2. **ATTENTION:** Radiation laser invisible quand l'appareil est ouvert ou que le verrouillage est en panne ou désactivé. Éviter une exposition directe au rayon.
3. **ATTENTION:** Ne pas ouvrir le couvercle du dessus. Il n'y a aucune pièce utilisable à l'intérieur. Laisser à un personnel qualifié le soin de réparer votre appareil.

Introduction

We would like to thank you for purchasing one of our JVC products. Before operating this unit, read this manual carefully and thoroughly to obtain the best possible performance from your unit, and retain this manual for future reference.

About This Manual

This manual is organized as follows:

- The manual mainly explains operations using the buttons and controls on the unit. You can also use the buttons on the remote control if they have the same or similar names (or marks) as those on the unit. If operation using the remote control is different from that using the unit, it is then explained.
- Basic and common information that is the same for many functions is grouped in one place, and is not repeated in each procedure. For instance, we do not repeat the information about turning on/off the unit, setting the volume, changing the sound effects, and others, which are explained in the section “Common Operations” on pages 8 and 9.
- The following marks are used in this manual:



Gives you warnings and cautions to prevent a damage or risk of fire/electric shock. Also gives you information on operation which is not good for obtaining the best possible performance from the unit.



Gives you information and hints you had better know.

Precautions

Installation

- Install in a place which is level, dry and neither too hot nor too cold — between 5°C (41°F) and 35°C (95°F).
- Install the unit in a location with adequate ventilation to prevent internal heat built-up in the unit.
- Leave sufficient distance between the unit and the TV.
- Keep the speakers away from the TV to avoid interference with TV.



DO NOT install the unit in a location near heat sources, or in a place subject to direct sunlight, excessive dust or vibration.

Power source

- When unplugging from the wall outlet, always pull the plug, not the AC power cord.



DO NOT handle the AC power cord with wet hands.

Moisture condensation

Moisture may condense on the lens inside the unit in the following cases:

- After starting heating in the room
 - In a damp room
 - If the unit is brought directly from a cold to a warm place
- Should this occur, the unit may malfunction. In this case, leave the unit turned on for a few hours until the moisture evaporates, unplug the AC power cord, and then plug it in again.

Others

- Should any metallic object or liquid fall into the unit, unplug the unit and consult your dealer before operating any further.
- If you are not going to operate the unit for an extended period of time, unplug the AC power cord from the wall outlet.



DO NOT disassemble the unit since there are no user serviceable parts inside.

If anything goes wrong, unplug the AC power cord and consult your dealer.

Contents

Location of the Buttons and Controls	3
Front Panel	4
Remote Control	5
Getting Started	6
Unpacking	6
Putting the Batteries into the Remote Control	6
Connections	6
Common Operations	8
Turning On or Off the Unit	8
Setting the Clock	8
Adjusting the Volume	8
Digital Sound Control	9
Listening to FM and AM Broadcasts	10
Tuning In a Station	10
Presetting Stations	10
Tuning In a Preset Station	10
Playing Back CDs	11
Loading a Disc	11
Basic CD Operations	11
Program Play	11
Random Play	12
Repeat Play	12
Introductory Play	12
Displaying the Remaining Time during Playback ..	12
Playing Back Tapes	13
Loading a Tape	13
Tape Playback	13
Rewind/Fast Forward	13
Recording	14
Recording Tapes	14
Using the Timers	15
Using Daily Timer	15
Timer Recording	15
Using Sleep Timer	16
Troubleshooting	17
Maintenance	18
Specifications	19

Location of the Buttons and Controls





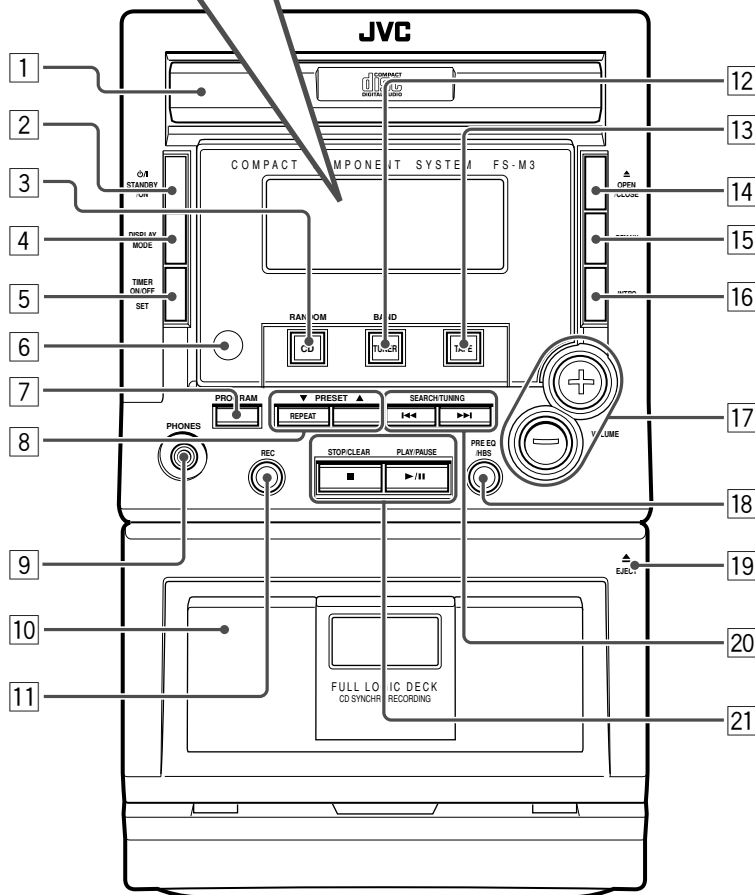
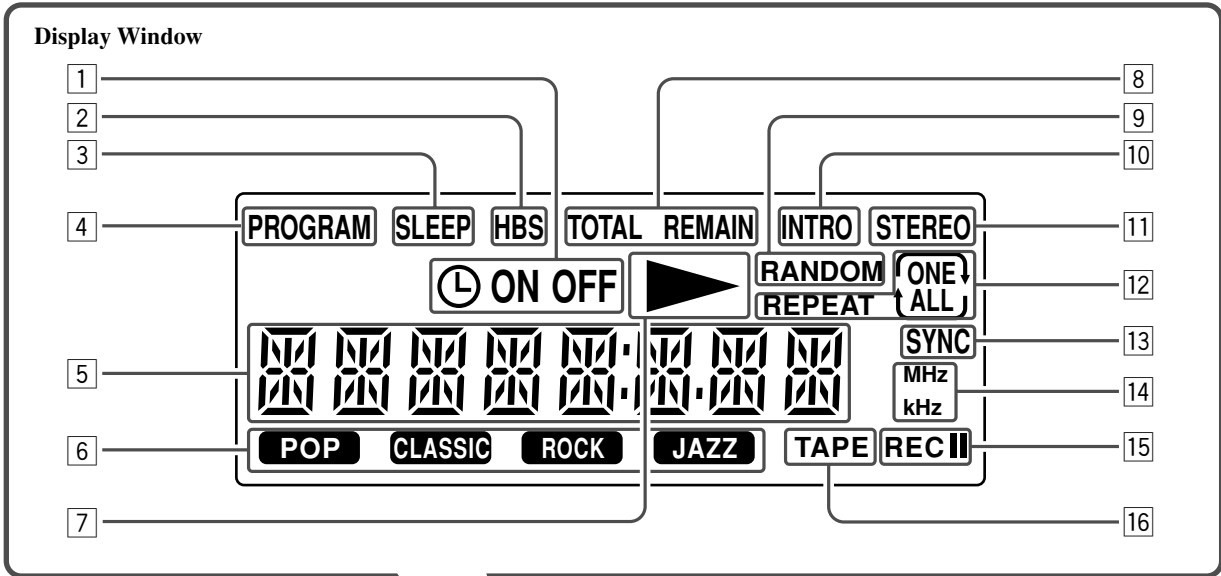



Become familiar with the buttons and controls on your unit.



Front Panel





Front Panel

See pages in the parentheses for details.

- 1 Disc compartment (11)
- 2  STANDBY/ON button (8)
Turns the unit on or off (standby mode).
- 3 CD/RANDOM button (11, 12)
*Selects CD mode.
Starts or stops random play in CD mode.*
- 4 DISPLAY MODE button (8, 15)
Displays the clock time or sets the timer.
- 5 TIMER ON/OFF SET button (15)
Activates/deactivates the timer.
- 6 Remote sensor (5)
Infrared sensor for remote control
- 7 PROGRAM button (8, 10, 11, 15)
*CD: programs the track playback order.
Tuner: presets radio stations.
Clock/Timer: sets the clock/timer.*
- 8 REPEAT button (12)
CD: repeats a track or the whole disc.
PRESET  /  buttons (10)
Tuner: Select a preset radio station.
- 9 PHONES jack (8)
Connect the headphones to this jack.
- 10 Tape deck (13)
- 11 REC  (recording) button (14)
Switches to the record-ready state.
- 12 TUNER/BAND button (10)
*Selects tuner mode.
Selects FM or AM in tuner mode.*
- 13 TAPE button (13)
Selects tape mode.
- 14  OPEN/CLOSE button (11)
Opens/closes the disc compartment.
- 15 REMAIN button (12)
CD: displays the remaining time of a track/disc or elapsed time of a disc during playback.
- 16 INTRO button (12)
CD: starts or stops introductory play.
- 17 VOLUME +/- buttons (8)
Adjust the volume.
- 18 PRE EQ/HBS button (9)
*Selects the desired sound mode.
Switches on or off the HBS system.*
- 19  EJECT (13)
Opens the tape deck door.
- 20 SEARCH/TUNING   buttons (8, 10, 11, 13, 15)
*CD: search backward/forward or skip to the beginning of the current/previous/next track.
Tuner: tune to a lower or higher radio frequency or search radio stations.
Tape: rewind or fast forward.
Clock/Timer: set the hour and minute.*

- 21 PLAY/PAUSE  button (11, 13)
*CD/Tape: starts or interrupts playback.
STOP/CLEAR  button (11, 13)
CD: stops playback or clears the program.
Tape: stops playback or recording.*

Display window

- 1  /ON/OFF (timer on/off) indicators (15)
- 2 HBS indicator (9)
- 3 SLEEP indicator (16)
- 4 PROGRAM indicator (10, 11)
- 5 Main display
- 6 Sound mode indicators (9)
POP, CLASSIC, ROCK, JAZZ
- 7  (play mode) indicator (11, 13)
- 8 TOTAL/REMAIN indicators (12)
- 9 RANDOM indicator (12)
- 10 INTRO indicator (12)
- 11 STEREO indicator (10)
- 12 REPEAT ONE/ALL indicators (12)
- 13 SYNC (synchronous recording) indicator (14)
- 14 MHz/kHz (frequency) indicators (10)
- 15 REC/ (recording/pause) indicators (14)
- 16 TAPE indicator (13)

Remote Control

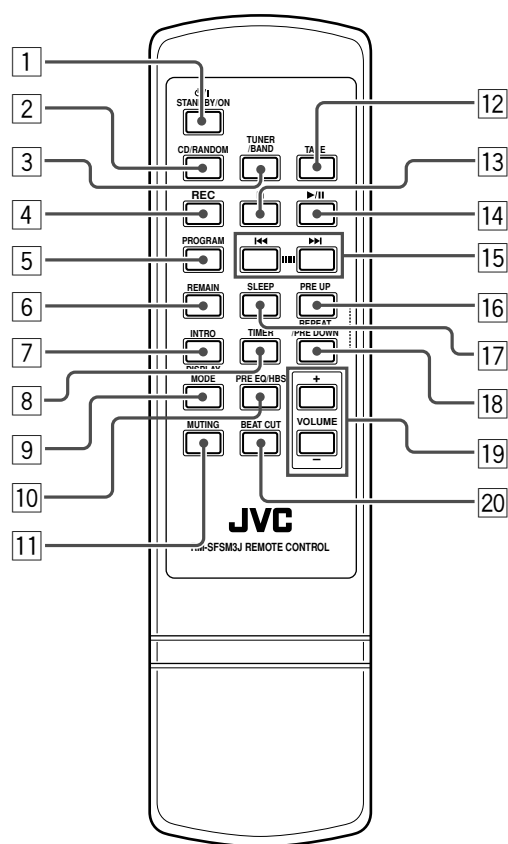

Remote Control

- 1 STANDBY/ON button
- 2 CD/RANDOM button
- 3 TUNER/BAND button
- 4 REC (recording) button
- 5 PROGRAM button
- 6 REMAIN button
- 7 INTRO button
- 8 TIMER button
- 9 DISPLAY MODE button
- 10 PRE EQ/HBS button
- 11 MUTING button

Interrupts and resumes sound reproduction.

- 12 TAPE button
- 13 button
- 14 button
- 15 buttons
- 16 PRE UP button
- 17 SLEEP button

Selects the time length until the unit is turned off.

- 18 REPEAT/PRE DOWN button
- 19 VOLUME +/- buttons
- 20 BEAT CUT button

Eliminates beats during AM broadcast recording.

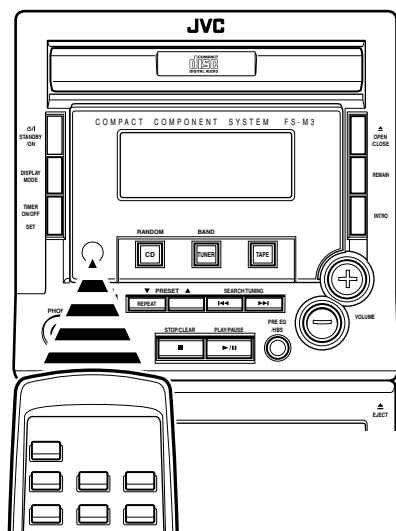

When using the remote control, point it at the remote sensor on the front panel.

Unpacking

After unpacking, check to be sure that you have all the following items.

The number in the parentheses following each item name indicates the supplied quantity.

- Remote control (1)
- Batteries (R03 (UM-4)/AAA (24F)) for the remote control (2)
- AM loop antenna (1)

If anything is missing, consult your dealer immediately.

Putting the Batteries into the Remote Control

Insert 2 batteries — R03 (UM-4)/AAA (24F) — into the battery compartment of the remote control, complying with the + and – polarity markings inside the battery compartment. When the remote control can no longer operate the unit, replace both batteries at the same time.

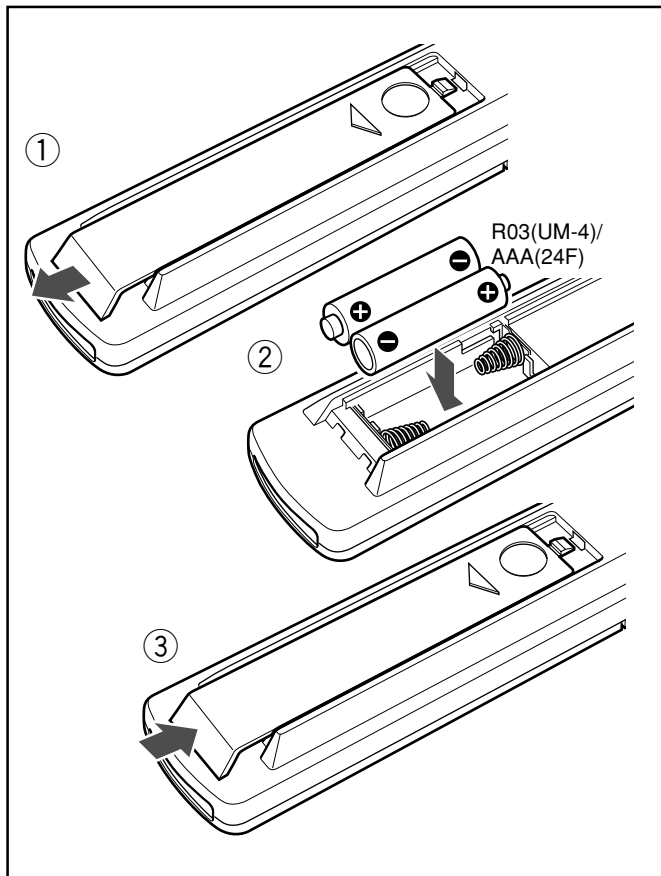

- DO NOT use an old battery together with a new one.
- DO NOT use different types of batteries together.
- DO NOT expose batteries to heat or flame.
- DO NOT leave the batteries in the battery compartment when you are not going to use the remote control for an extended period of time; otherwise, the remote control may be damaged by battery leakage.

Connections



- DO NOT connect any equipment to the unit while the unit is powered.
- DO NOT plug in any equipment until all connections are completed.

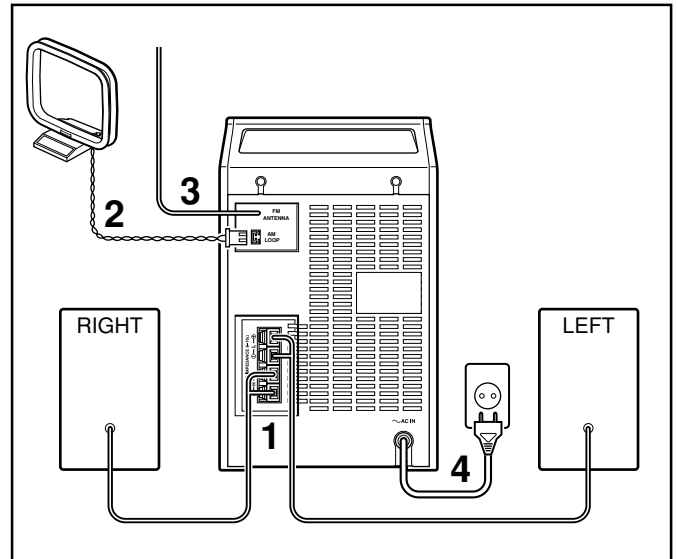

1 Connect the speakers.

Connect the right speaker to the “R” terminals, with the red wire to + and the black wire to –.

Connect the left speaker to the “L” terminals in the same way.

Clip the stripped portion of each speaker wire as shown in the illustration.

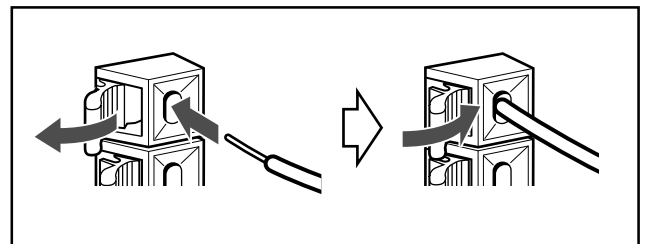

2 Connect the supplied AM loop antenna to the AM LOOP terminal.

Place the antenna away from the unit and adjust its position for the best reception.

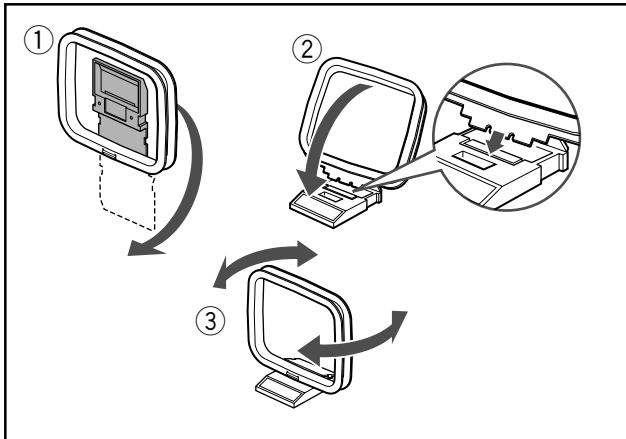

3 Adjust the position of the FM antenna for the best reception.

4 Connect the AC power cord of the unit to the AC outlet after all other connections have been made.

Turning On or Off the Unit

To turn on the unit

Press  STANDBY/ON on the unit or remote control.

The unit turns on with the last source selection remaining valid.

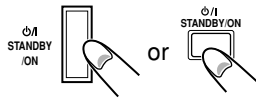

To turn off the unit (on standby)

Press  STANDBY/ON on the unit or remote control.

The clock time appears if the clock is already set.

Setting the Clock

Before operating the unit any further, first set the built-in clock.

1 When the unit is in standby mode, press and hold PROGRAM until the hour indication starts blinking.



- When the unit is on, press DISPLAY MODE to enter clock mode, then press and hold PROGRAM.

2 Press or to set the hour, then press PROGRAM.

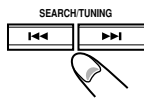

The minute indication starts blinking.

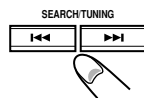

3 Press or to set the minute, then press PROGRAM to store the setting.

The clock starts working.



To change the hour or minute indication rapidly in steps 2 and 3, press and hold  or .

To select 12-hour or 24-hour display mode

In standby mode, hold down  and press PROGRAM repeatedly.

With each press, the selection toggles between 12-hour and 24-hour modes.

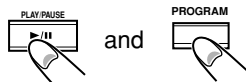

- In 12-hour mode, “AM 12:00” indicates midnight and “PM 12:00” indicates noon.

To check the clock time while the unit is on

Press DISPLAY MODE.

The clock time is displayed until you press any key.



To correct the clock time

Carry out steps 1 to 3 above.



On clock resetting

If a power failure occurs or the AC power cord is disconnected, the clock is reset to “AM 12:00” (flashing). In such a case you need to set the clock again.

Adjusting the Volume

- You can adjust the volume only while the unit is turned on.

Press VOLUME + or VOLUME – to increase or decrease the volume level.



The volume can be adjusted in 41 steps between “VOL MIN” (minimum) and “VOL MAX” (maximum).

To increase or decrease the volume level rapidly, press and hold VOLUME + or VOLUME –.

To turn off the sound temporarily

Press MUTING on the remote control.

Playback continues without sound and “MUTING” appears on the display.



To restore the sound, press MUTING again or increase or decrease the volume level.



For private listening

Connect a pair of headphones to the PHONES jack. No sound comes out of the speakers. Be sure to turn down the volume before connecting or putting on headphones.



DO NOT turn off the unit (on standby) with the volume set to an extremely high level; otherwise, a sudden blast of sound can damage your hearing and/or the speakers when you turn on the unit or start playing any source next time.

Digital Sound Control

The unit's digital sound control feature enables you to select desired preset equalizer settings (selectable as sound modes) to enjoy special sound effects matching the music type. You can also use the HBS (Hyper Bass Sound) system to enjoy powerful bass sound created by emphasizing low frequencies.

To select the desired sound mode

Press PRE EQ/HBS repeatedly.



Each time you press the button, the sound mode changes as follows:

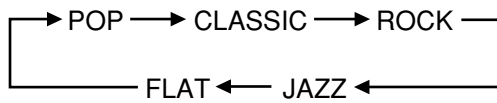

- POP: More presence in the vocals and midrange
- CLASSIC: Enriched sound with fine treble and ample bass
- ROCK: Powerful sound emphasizing treble and bass
- JAZZ: Accented lower frequencies for jazz-type music
- FLAT: Equalizer effect is canceled.

To switch the HBS system on/off

Press and hold PRE EQ/HBS until "HBS ON" or "HBS OFF" appears on the display.



When the HBS system is switched on, the HBS indicator lights up on the display.

Listening to FM and AM Broadcasts

Tuning In a Station

- 1 When the unit is turned on, press TUNER/BAND to select tuner mode.**

The unit tunes in the last station tuned in (either FM or AM).



- 2 Press TUNER/BAND to select the band, FM or AM.**

Each time you press the button, the band selection alternates between FM and AM.



- 3 Press and hold ◀◀ or ▶▶ for more than 1 second.**

The unit starts searching for stations and stops when a station of sufficient signal strength is tuned in.

If a program is broadcast in stereo, the STEREO indicator lights up.

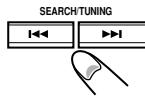

To stop searching, press ◀◀ or ▶▶.



When you press ◀◀ or ▶▶ briefly and repeatedly the frequency changes step by step.

Presetting Stations

You can preset 20 FM and 20 AM stations.

- There is a time limit in doing the following steps. If the setting is canceled before you finish, start from step 1 again.

- 1 Tune in the station you want to preset.**

- See “Tuning In a Station” on the left.

- 2 Press PROGRAM.**

The PROGRAM indicator and “00” start blinking on the display.



- 3 Press PRESET ▼ or ▲ (or REPEAT/PRE DOWN or PRE UP on the remote control) to specify the desired preset number.**

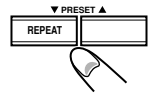

- 4 Wait a few seconds to confirm the preset number.**

- Alternatively, press PROGRAM.

- 5 To preset more stations, repeat the steps above, allocating a different preset number to each station.**



When a new station is stored

The station previously memorized with the same preset number is erased. (The frequency of the new station replaces the previous frequency in memory.)

Tuning In a Preset Station

- 1 Press TUNER/BAND to select tuner mode.**



- 2 Press TUNER/BAND to select the band, FM or AM.**

- 3 Press PRESET ▼ or ▲ (or REPEAT/PRE DOWN or PRE UP on the remote control) to select the desired preset number.**

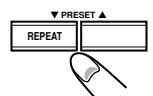

Playing Back CDs

This unit can play back audio CDs.



Loading a Disc

1 Press **CD/RANDOM** to select CD mode.



2 Press **▲ OPEN/CLOSE**.

The disc tray slides out.



3 Load a disc with the label side facing up.

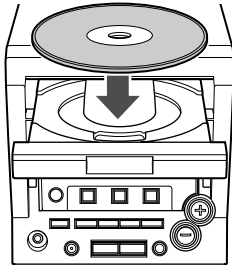

4 Press **▲ OPEN/CLOSE** to close the disc compartment.

The total number of tracks and the playing time of the disc appear on the display.



Basic CD Operations

1 Press **▶/||** to start playback.

The ▶ indicator lights up and the track number and elapsed playing time of the current track appear on the display.



2 To stop playback, press **■**.



To interrupt playback

Press **▶/||**.

The ▶ indicator and the playing time start blinking.



To resume playback, press **▶/||** again.

To select a desired track

Press **◀◀** or **▶▶** repeatedly until the desired track appears on the display.

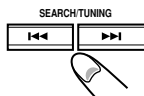

To search for a particular point during playback

Press and hold **◀◀** or **▶▶** to locate the desired point.



Program Play

You can arrange the order in which the tracks are played before you start playing. You can program up to 60 tracks.

1 In stop mode, press **PROGRAM**.

The PROGRAM indicator starts blinking.



2 Press **◀◀** or **▶▶** repeatedly to select the desired track.

The current program number starts blinking.



3 Press **PROGRAM** to store the selected track.

“00” and the next program number appear on the display.



4 Repeat steps 2 and 3 to store other tracks.

- You cannot program more than 60 tracks. If you attempt to do it, “FULL” will flash on the display.

To review the programmed sequence

Press PROGRAM repeatedly in stop mode. The program number and track number are displayed in succession.



To modify the program

Press PROGRAM repeatedly to select the program number with which you want to change the track, then repeat steps 2 and 3 above.



To play the programmed tracks

Press **▶/||**.



- During program play, you can press **◀◀** or **▶▶** to select the desired track in the program.



If you press REPEAT during program play

The current track or all programmed tracks are played repeatedly.

To clear the program

Press **■** in stop mode.

The PROGRAM indicator disappears from the display.



- The stored program is cleared when the CD compartment is opened.

Random Play

You can play all the tracks in random order.

Press CD/RANDOM before or during playing.

The RANDOM indicator lights up.

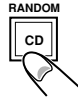

To exit random play mode, press CD/RANDOM again. The RANDOM indicator goes off.

- Activating the REPEAT ONE function during random play mode disables the random play mode.
- It is not possible to activate the random play function during program play mode.

Repeat Play

You can play the current track or the whole disc repeatedly.

Press REPEAT repeatedly to select either of the following repeat play modes:

REPEAT ONE: repeats the current track.
REPEAT ALL: repeats the whole disc.



The current track or the whole disc is played repeatedly until you press ■.

To exit repeat play mode, press REPEAT repeatedly so that the REPEAT indicator disappears from the display.

- Activating the random play function during REPEAT ONE play mode disables the repeat play mode.

Introductory Play

The introductory portions of tracks can be played back automatically.

Press INTRO.

The first 10-second portion of each of the tracks is played back in order.



To exit introductory play mode, press INTRO again.

- The introductory play function is also available during program play mode, random play mode and repeat play mode.

Displaying the Remaining Time during Playback

You can display the remaining time of the current track/disc and the elapsed time of the current track/disc during playing a CD.

Press REMAIN repeatedly to select one of the following time display modes:

REMAIN: shows the remaining time of the current track.
TOTAL REMAIN: shows the remaining time of the disc.
TOTAL: shows the elapsed time of the disc.
No indication: shows the elapsed time of the current track.



Playing Back Tapes

- Use only type I normal tapes.



The use of tapes longer than 120 minutes is not recommended, since characteristic deterioration may occur and these tapes easily jam in the pinchroller and the capstan.

Loading a Tape

- 1 Press **EJECT** to open the tape deck door.

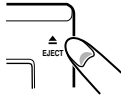

- 2 Insert a recorded tape with the open side down and playback side facing out from the unit.

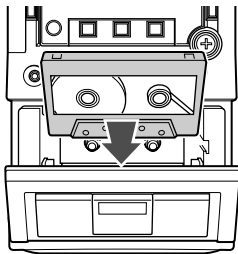

- 3 Close the tape deck door.

The TAPE indicator appears on the display.

Tape Playback

- 1 When the unit is turned on, press **TAPE**.



- 2 Press **▶/II**.

Playback starts.
“PLAY” and the ▶ indicator appear on the display.



- 3 To stop playback, press **■**.



To interrupt playback

Press **▶/II**.

The ▶ indicator starts blinking and “PAUSE” appears on the display.



To resume playback, press **▶/II** again.

Rewind/Fast Forward

- 1 Press **◀◀** or **▶▶** to rewind or fast forward the tape.

“REW” or “FF” appears on the display.

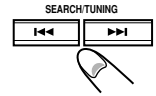

- 2 Press **■** to stop rewinding or fast forwarding.



- The tape stops automatically at the end of the rewinding or fast forwarding.

Recording

IMPORTANT:

- It should be noted that it may be unlawful to re-record pre-recorded tapes, records, or discs without the consent of the owner of copyright in the sound or video recording, broadcast or cable program and in any literary, dramatic, musical, or artistic content embodied therein.
- The recording level is automatically set correctly, so it is not affected by the volume control. Thus, during recording you can adjust the sound you are actually listening to without affecting the recording level.
- While recording, you can hear sound modes and/or the HBS sound effect through the speakers. However, the sound is recorded without these effects (see page 9).
- If recordings you have made have excessive noise or static, the unit may be too close to a TV. Increase the distance between the TV and the unit.
- Use only type I normal tapes for recording.
- The use of tapes longer than 120 minutes is not recommended, since characteristic deterioration may occur and these tapes easily jam in the pinchroller and the capstan.

To protect your recording

Cassettes have two small tabs on the back to prevent unexpected erasure or re-recording.

To protect your recording, remove these tabs.

To re-record on a protected tape, cover the holes with adhesive tape.

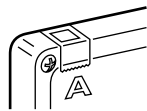

Recording Tapes

1 Load a recordable tape into the tape deck.

Insert a tape with the open side down and the side to be recorded facing out from the unit.

2 Press CD/RANDOM or TUNER/BAND to select the desired recording source.

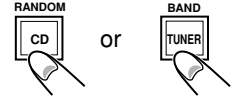

3 Prepare the source.

• For synchronous recording of a CD

Load the disc (see page 11).

- To start recording from the desired track, select the track by pressing **◀◀** or **▶▶** repeatedly in stop mode.
- To start recording from the desired point on a disc, play the disc and pause at the desired point by pressing **▶/||**.

• For recording from the radio

Tune in the desired station (see page 10).

4 Press REC.

“REC” is displayed. The TAPE REC indicator and “II” light up and the recording direction indicator starts blinking.



5 Press ▶/|| for recording.

Recording starts.

“II” goes off. The TAPE REC indicator remains on the display. When recording a CD, the SYNC indicator also lights up.



To stop recording, press ■.

The selected recording source continues playing.

- During recording, it is not possible to pause or listen to another source. “REC ON” appears on the display.
- Recording continues to the end of the tape until you press ■ even after playback of the CD has finished.

Using the BEAT CUT function

When recording an AM broadcast, beats may occur. If this happens, press BEAT CUT on the remote control to select the better beat-cut position, “BEAT 01” or “BEAT 02”.

Using the Timers

There are three timers available – daily timer, recording timer and sleep timer.

Before using the timers, you need to set the built-in clock (see page 8).

Using Daily Timer

With the daily timer, you can wake to your favorite music or radio program.

How the daily timer actually works

At the timer-on time, the unit automatically turns on, sets the volume to the preset level, and starts playing the specified source (radio or CD). Then, at the timer-off time, the unit automatically turns off (on standby).

The timer setting remains in memory until you change it.

- There is a time limit in doing the following steps. If the setting is canceled before you finish, start from step 1 again.

- 1 Press and hold DISPLAY MODE until “⌚ ON” starts blinking on the display, then press PROGRAM.**

The hour indication starts blinking.

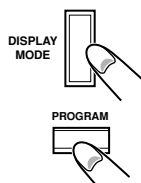

- 2 Press |◀◀ or ▶▶| to set the timer start hour, then press PROGRAM.**

The minute indication starts blinking.

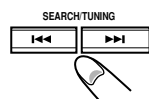

- 3 Press |◀◀ or ▶▶| to set the minute, then press PROGRAM.**

“⌚ ON” starts blinking again.

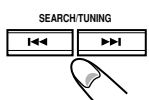

- 4 Press DISPLAY MODE so that “⌚ OFF” starts blinking on the display, then press PROGRAM.**

The hour indication starts blinking.

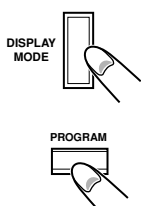

- 5 Set the time to stop playback following the same procedure as steps 2 and 3.**

- 6 Press DISPLAY MODE so that “TUNER”, “TAPE”, “CD” or “REC TU” appears on the display, then press PROGRAM.**

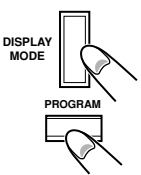

- 7 Press |◀◀ or ▶▶| to select the desired source, then press PROGRAM.**

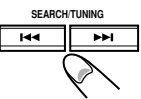

- 8 Prepare the source and set the volume.**

To listen to the radio, tune in the desired station.

To listen to a CD, load the disc.

- 9 Press TIMER ON/OFF SET (or TIMER on the remote control) to activate the timer.**

“⌚” lights up on the display.

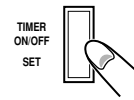

- 10 Turn off the unit (on standby).**

When the preset time is reached, the selected source is played if the timer has been activated.



To deactivate the timer, press TIMER ON/OFF SET (or TIMER on the remote control).

“⌚” disappears from the display.

- The timer-off function is not activated if the starting and stopping times are the same.
- If the selected source (CD or TAPE) is not available when the preset time is reached, TUNER is selected automatically.

Timer Recording

You can use the recording timer to record a preset radio station from a specified time and for a specified duration automatically.

- 1 Load a recordable tape into the tape deck.**

Insert a tape with the open side down and the side to be recorded facing out from the unit.

- 2 Follow the “Using Daily Timer” procedure on the left. Select “REC TU” as the source for timer recording.**

- If the preset time is reached while the unit is on, the timer is not activated for timer recording.
- The recording timer is canceled once the recording is finished.

Using Sleep Timer

With the sleep timer, you can fall asleep to music. You can set the sleep timer using the remote control when the unit is turned on.

How the sleep timer actually works

The unit automatically turns off after the specified time length passes.

1 Press and hold SLEEP on the remote control until the desired time length appears on the display.



The time length changes from 90 to 10 minutes in 10-minute steps.

2 Wait for a moment after specifying the time length.

The SLEEP indicator lights up steadily on the display.

- Setting both the timer-off and sleep-off times causes the unit to enter standby mode when the earlier one of them is reached.

To change the shut-off time, repeat the procedure above.

To cancel the setting, press SLEEP so that the SLEEP indicator goes off.

- The sleep timer is also canceled when you turn off the unit.

Troubleshooting

If you are having a problem with your unit, check this list for a possible solution before calling for service.

If you cannot solve the problem from the hints given here, or the unit has been physically damaged, call a qualified person, such as your dealer, for service.

Symptom	Cause	Action
No sound is heard.	<ul style="list-style-type: none"> • Connections are incorrect or loose. • Headphones are connected. 	<ul style="list-style-type: none"> • Check all connections and make corrections (see pages 6 and 7). • Disconnect the headphones.
Hard to listen to broadcasts because of noise.	<ul style="list-style-type: none"> • Antennas are disconnected. • The AM loop antenna is too close to the unit. • The FM antenna is not properly extended and positioned. 	<ul style="list-style-type: none"> • Reconnect the antennas correctly and securely. • Change the position and direction of the AM loop antenna. • Extend the FM antenna at the best position.
The disc tray does not open or close.	The AC power cord is not plugged in.	Plug the AC power cord.
The disc does not play.	The disc is placed upside down.	Place the disc with the label side up.
The disc sound is discontinuous.	The disc is scratched or dirty.	Clean or replace the disc (see page 18).
The cassette holder cannot be opened.	Power supply from the AC power cord has been cut off while the tape was running.	Turn on the unit.
Impossible to record.	Small tabs on the back of the cassette are removed.	Cover the holes with adhesive tape.
Operations are disabled.	The built-in microprocessor may malfunction due to external electrical interference.	Unplug the AC power cord and then plug it back in.
Unable to operate the unit from the remote control.	<ul style="list-style-type: none"> • The path between the remote control and the remote sensor on the unit is blocked. • The batteries are exhausted. 	<ul style="list-style-type: none"> • Remove the obstruction. • Replace the batteries.

Maintenance

To get the best performance of the unit, keep your discs, tapes, and mechanism clean.

Handling discs



- Remove the disc from its case by holding it at the edge while pressing the center hole lightly.
- Do not touch the shiny surface of the disc, or bend the disc.
- Put the disc back in its case after use to prevent warping.

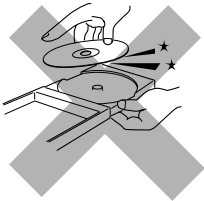

- Be careful not to scratch the surface of the disc when placing it back in its case.
- Avoid exposure to direct sunlight, temperature extremes, and moisture.



To clean the disc

Wipe the disc with a soft cloth in a straight line from center to edge.



DO NOT use any solvent — such as conventional record cleaner, spray, thinner, or benzine — to clean the disc.

Handling cassette tapes

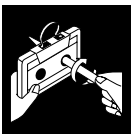

- If the tape is loose in its cassette, take up the slack by inserting a pencil in one of the reels and rotating.
- If the tape is loose, it may get stretched, cut, or caught in the cassette.



- Be careful not to touch the tape surface.



- Avoid the following places to store the tape:
 - In dusty places
 - In direct sunlight or heat
 - In moist areas
 - Near a magnet

Cassette deck

If the heads, capstan, and pinch roller of the cassette deck become dirty, the following will occur:

- Impaired sound quality
- Discontinuous sound
- Fading
- Incomplete erasure
- Difficulty in recording

To clean the heads, capstan, and pinch roller

Use a cotton swab moistened with alcohol.

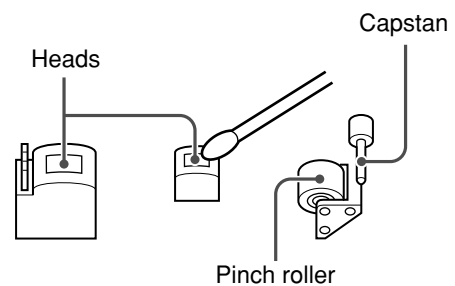

To demagnetize the heads

Turn off the unit, and use a head demagnetizer (available at electronics and record shops).

Cleaning the unit

• Stains on the unit

Should be wiped off with a soft cloth. If the unit is heavily stained, wipe it with a cloth soaked in water diluted neutral detergent and wrung well, then wipe clean with a dry cloth.

• Since the unit may deteriorate in quality, become damaged or get its paint peeled off, be careful about the followings.

- DO NOT wipe it with a hard cloth
- DO NOT wipe it strong
- DO NOT wipe it with thinner or benzine.
- DO NOT apply any volatile substance such as insecticides to it.
- DO NOT allow any rubber or plastic to remain in contact with it for a long time.

Specifications

Amplifier section

Output power	10 W per channel, min. RMS, driven into 8 Ω at 1 kHz with no more than 10% total harmonic distortion
Audio output level	PHONES: 20 mW/ch output into 32 Ω
Speakers/Impedance	8 Ω - 16 Ω

Tuner

FM tuning range	87.5 MHz - 108.0 MHz
AM tuning range	530 kHz - 1 710 kHz

CD player

Dynamic range	60 dB
Signal-to-noise ratio	60 dB
Wow and flutter	Unmeasurable

Cassette deck

Frequency response	Normal (type I): 100 Hz - 10 000 Hz
Wow and flutter	0.35% (WRMS)

General

Power requirement	AC 120 V \sim , 60 Hz
Power consumption	30 W (operation mode) 8 W (standby mode)
Dimensions	160 mm \times 269.5 mm \times 300 mm (6 ⁻¹⁵ / ₁₆ " \times 10 ⁻⁵ / ₈ " \times 11 ⁻¹³ / ₁₆ " (W/H/D)
Mass	4.3 kg (9.5 lbs)

Speaker

Speaker unit	Woofer: 10.2 cm (4 ⁻¹ / ₁₆ ") cone \times 1 Tweeter: 5.1 cm (2 ⁻¹ / ₁₆ ") cone \times 1
Impedance	8 Ω
Dimensions	160 mm \times 269.5 mm \times 192 mm (6 ⁻¹⁵ / ₁₆ " \times 10 ⁻⁵ / ₈ " \times 7 ⁻⁹ / ₁₆ " (W/H/D)
Mass	2 kg (4.5 lbs)/piece

Supplied accessories

See page 6.

Design and specifications are subject to change without notice.

Authorized Service Centers

QUALITY **JVC**[®] SERVICE
HOW TO LOCATE YOUR JVC SERVICE CENTER
TOLL FREE: 1 (800) 537-5722
<http://www.jvc.com>

Dear Customer,

In order to receive the most satisfaction from your purchase, please read the instruction booklet before operating the unit. In the event that repairs are necessary, please call 1 (800)537-5722 for your nearest authorized servicer or visit our website at **www.JVC.com**

Remember to retain your Bill of Sale for Warranty Service.

Do not service the television yourself

Caution

To prevent electrical shock, do not open the cabinet. There are no user serviceable parts inside. Please refer to qualified service personnel for repairs.

Accessories

To purchase accessories for your JVC product, please call toll free: 1 (800)882-2345 or on the web at **www.JVC.com**



LIMITED WARRANTY

AUDIO-1

JVC COMPANY OF AMERICA warrants this product and all parts thereof, except as set forth below ONLY TO THE ORIGINAL PURCHASER AT RETAIL to be FREE FROM DEFECTIVE MATERIALS AND WORKMANSHIP from the date of original retail purchase for the period as shown below. ("The Warranty Period")

PARTS	1 YR	LABOR	1 YR
-------	-------------	-------	-------------

THIS LIMITED WARRANTY IS VALID ONLY IN THE FIFTY (50) UNITED STATES, THE DISTRICT OF COLUMBIA AND IN COMMONWEALTH OF PUERTO RICO.

WHAT WE WILL DO:

If this product is found to be defective, JVC will repair or replace defective parts at no charge to the original owner. Such repair and replacement services shall be rendered by JVC during normal business hours at JVC authorized service centers. Parts used for replacement are warranted only for the remainder of the Warranty Period. All products and parts thereof may be brought to a JVC authorized service center on a carry-in basis except for Television sets having a screen size 25 inches and above which are covered on an in-home basis.

WHAT YOU MUST DO FOR WARRANTY SERVICE:

Return your product to a JVC authorized service center with a copy of your bill of sale. For your nearest JVC authorized service center, please call toll free: (800) 537-5722.

If service is not available locally, box the product carefully, preferably in the original carton, and ship, insured, with a copy of your bill of sale plus a letter of explanation of the problem to the nearest JVC Factory Service Center, the name and location of which will be given to you by the toll-free number.

If you have any questions concerning your JVC Product, please contact our Customer Relations Department.

WHAT IS NOT COVERED:

This limited warranty provided by JVC does not cover:

1. Products which have been subject to abuse, accident, alteration, modification, tampering, negligence, misuse, faulty installation, lack of reasonable care, or if repaired or serviced by anyone other than a service facility authorized by JVC to render such service, or if affixed to any attachment not provided with the products, or if the model number or serial number has been altered, tampered with, defaced or removed;
2. Initial installation and installation and removal for repair;
3. Operational adjustments covered in the Owner's Manual, normal maintenance, video and audio head cleaning;
4. Damage that occurs in shipment, due to act of God, and cosmetic damage;
5. Signal reception problems and failures due to line power surge;
6. Video Pick-up Tubes/CCD Image Sensor, Cartridge, Stylus (Needle) are covered for 90 days from the date of purchase;
7. Accessories
8. Batteries (except that Rechargeable Batteries are covered for 90 days from the date of purchase);

There are no express warranties except as listed above.

THE DURATION OF ANY IMPLIED WARRANTIES, INCLUDING THE IMPLIED WARRANTY OF MERCHANTABILITY, IS LIMITED TO THE DURATION OF THE EXPRESS WARRANTY HEREIN.

JVC SHALL NOT BE LIABLE FOR THE LOSS OF USE OF THE PRODUCT, INCONVENIENCE, LOSS OR ANY OTHER DAMAGES, WHETHER DIRECT, INCIDENTAL OR CONSEQUENTIAL (INCLUDING, WITHOUT LIMITATION, DAMAGE TO TAPES, RECORDS OR DISCS) RESULTING FROM THE USE OF THIS PRODUCT, OR ARISING OUT OF ANY BREACH OF THIS WARRANTY. ALL EXPRESS AND IMPLIED WARRANTIES, INCLUDING THE WARRANTIES OF MERCHANTABILITY AND FITNESS FOR PARTICULAR PURPOSE, ARE LIMITED TO THE WARRANTY PERIOD SET FORTH ABOVE.

Some states do not allow the exclusion of incidental or consequential damages or limitations on how long an implied warranty lasts, so these limitations or exclusions may not apply to you. This warranty gives you specific legal rights and you may also have other rights which vary from state to state.

JVC COMPANY OF AMERICA 1700 Valley Road
 DIVISION OF JVC AMERICAS CORP. Wayne, NJ 07470

REFURBISHED PRODUCTS CARRY A SEPARATE WARRANTY, THIS WARRANTY DOES NOT APPLY. FOR DETAILS OF REFURBISHED PRODUCT WARRANTY, PLEASE REFER TO THE REFURBISHED PRODUCT WARRANTY INFORMATION PACKAGED WITH EACH REFURBISHED PRODUCT.

For customer use:

Enter below the Model No. which is located either on the rear, bottom or side of the cabinet. Retain this information for future reference.

Model No. : _____ Serial No. : _____

Purchase data : _____ Name of dealer : _____

MEMO

A series of thin, horizontal black lines spaced evenly down the page, providing a template for writing the memo's content.

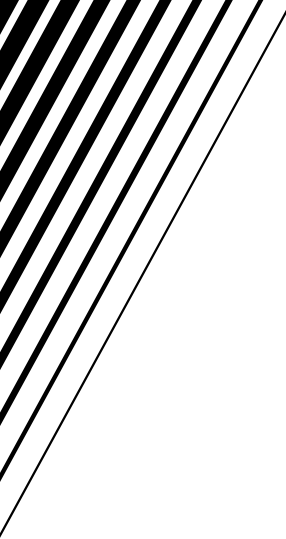

JVC
VICTOR COMPANY OF JAPAN, LIMITED